



FAP3

ARTICOLI TECNICI PER MOBILI E ARREDAMENT

CATALOGO

2021

La **FAP 3 s.n.c.** è un'azienda commerciale presente sul mercato da oltre 30 anni.

Operante soprattutto nel triveneto, mette a disposizione della propria clientela tutto il know-how e l'esperienza maturata.

La velocità delle consegne e la completezza nella preparazione degli ordini sono i caratteri distintivi della FAP 3.

Affiancandosi a partner commerciali nazionali e internazionali di alto livello tecnologico, la FAP 3 risulta essere sempre all'avanguardia con le esigenze di mercato e nel proporre le novità.

L'ampia gamma di prodotti sempre disponibili a magazzino, permette di soddisfare tutte le richieste da parte della clientela.

FAP 3 il partner giusto su cui contare.



PARETI ATTREZZATE





PARETI ATTREZZATE

PROFILO ORIZZONTALE PER DOGATO

Profilo alluminio



Art. N.

H.27X13mm lg.5000mm: alluminio naturale

420501

Coppia reggimensola ferro

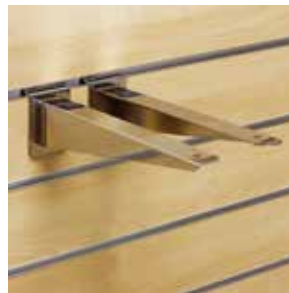

Art. N.

Coppia 200mm: cromo lucido

420515

Coppia 250mm: cromo lucido

420516

Coppia 300mm: cromo lucido

420520

Gancio dispenser ferro



Art. N.

150mm: cromo lucido

420530

200mm: cromo lucido

420531

250mm: cromo lucido

420532

Gancio singolo ferro



Art. N.

100mm: cromo lucido

420540

150mm: cromo lucido

420541

200mm: cromo lucido

420542

250mm: cromo lucido

420543

Broche dritta per dogato



Art. N.

lg.300mm: cromo lucido

420545

Broche inclinata per dogato



Art. N.

lg.297mm 7 pioli: cromo lucido

420525

Reggimensola per pesi leggeri:



Art. N.

cromo lucido

420536

Gancio portacassettiere in ferro



Art. N.

cromo lucido

420535



PROFILI CREMAGLIERA PANNELLABILI VERTICALE A PASSO 37mm per pannellatura 18-19mm senza lavorazioni.

Complete di fori di fissaggio asolati in orizzontale da 5x7mm passo 111mm ed in verticale da 5x10,5mm passo 222mm

Cremagliera alluminio centrale con foratura singola C1910A



Pannelli **sp.18-19 mm** senza lavorazioni e bordi in testa

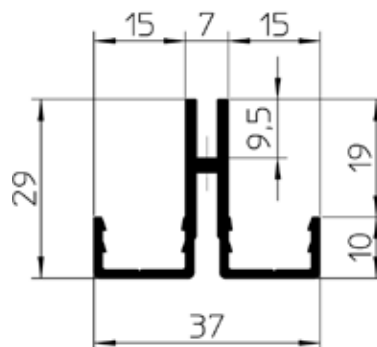

Art. N.

Ig.3012mm - Anodizzato argento

420554

Ig.2531mm - Anodizzato argento

420554A

Cremagliera alluminio centrale con foratura doppia C1912A

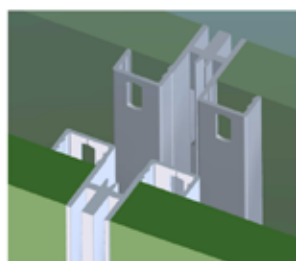
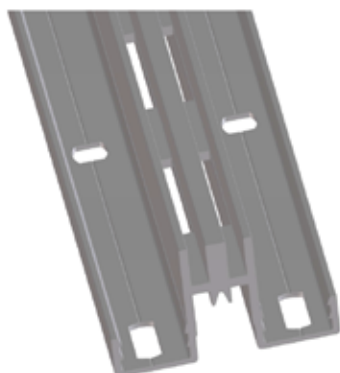

Pannelli **sp.18-19 mm** senza lavorazioni e bordi in testa

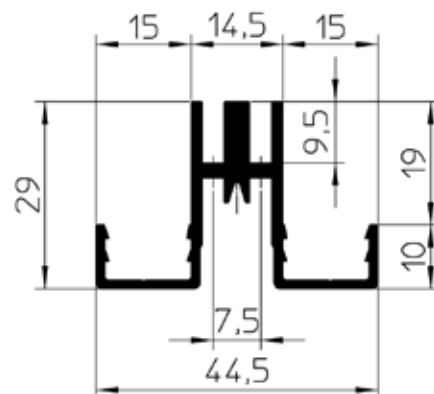

Art. N.

Ig.3012mm - Anodizzato argento

420555

Ig.2531mm - Anodizzato argento

420555A

Cremagliera alluminio laterale con foratura singola C1911A

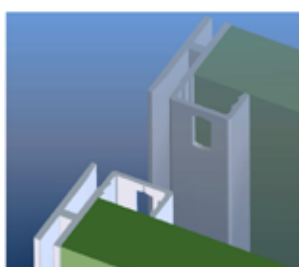

Pannelli **sp.18-19 mm** senza lavorazioni e bordi in testa

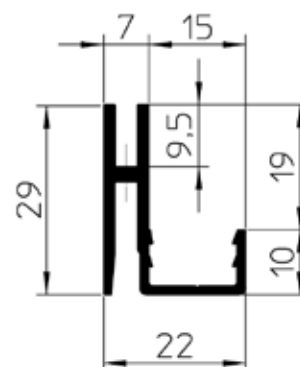

Art. N.

Ig.3012mm - Anodizzato argento

420556

Ig.2531mm - Anodizzato argento

420556A



Profilo laterale/terminale B0001A

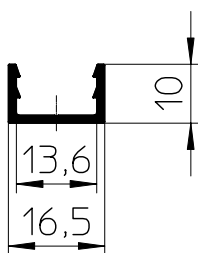

Art. N.

lg.3012mm grezzo

420557

Clip fissaggio60030P



Art. N.

in nylon

420558

Profilo cremagliera C0020A passo 37mm

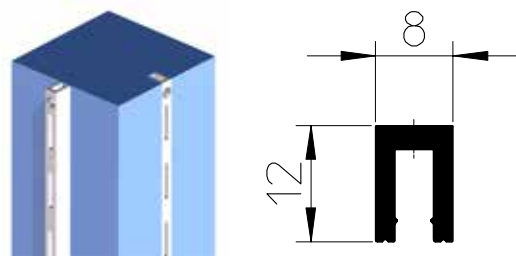

Per applicazione su pannelli a vista o ad incasso.
Completo di fori per il fissaggio svasati d. 3,7mm, ad un passo di 222mm.
Lunghezza 3012mm.

Art. N.

8x12mm lg.3012mm alluminio anod. argento

420553

REGGIMENSOLA IN ACCIAIO MODELLO MURANO M0130

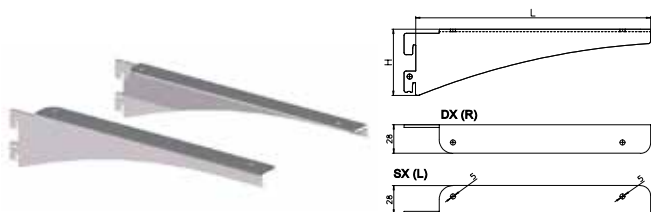

G= n° agganci

Art. N.

Mensola dx L=230mm H=65mm G=2 - Grigio bucciato 9006	420580
Mensola sx L=230mm H=65mm G=2 - Grigio bucciato 9006	420580A
Mensola dx L=330mm H=67mm G=2 - Grigio bucciato 9006	420581
Mensola sx L=330mm H=67mm G=2 - Grigio bucciato 9006	420581A
Mensola dx L=380mm H=110mm G=3 - Grigio bucciato 9006	420582
Mensola sx L=380mm H=110mm G=3 - Grigio bucciato 9006	420282A
Mensola dx L=310mm - G=2 Inox lucido	420583
Mensola sx L=310mm - G=2 Inox lucido	420583A
Mensola dx L=410mm - G=2 Inox lucido	420584
Mensola sx L=410mm - G=2 Inox lucido	420584A

REGGIMENSOLA IN ALLUMINIO MODELLO ROMA M0011A

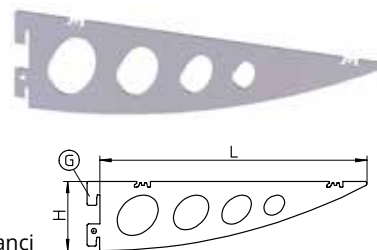

G= n° agganci

Art. N.

Mensola L=180mm H=54mm G=2 - Anodizzato argento	420560P
Mensola L=230mm H=60mm G=2 - Anodizzato argento	420561P
Mensola L=330mm H=90mm G=3 - Anodizzato argento	420563P
Mensola L=380mm H=101mm G=3 - Anodizzato argento	420564P



Mensola porta piano e appenderia M0225F
con bloccaggio per tubo ovale da 30x15mm sp.1,5mm

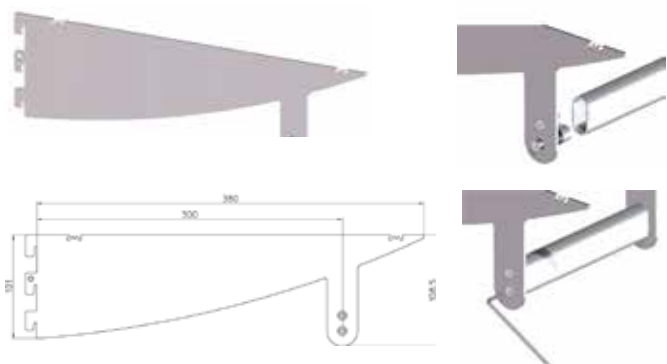

Ig.380mm porta piano-appenderia acciaio dx:
grigio bucciato 9006

Art. N.
420600P

Ig.380mm porta piano-appenderia acciaio sx:
grigio bucciato 9006

420601P

Mensola inclinabile M0300F

con piega dx o sx per piano inclinabile

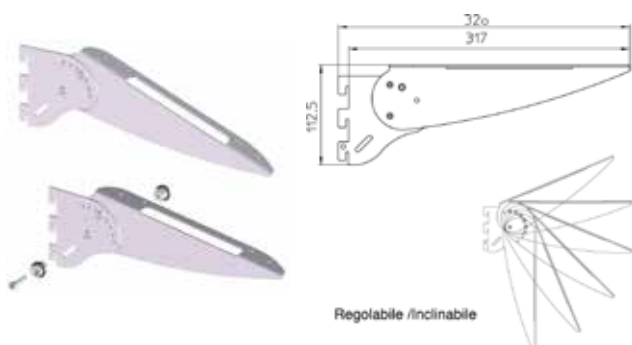

Può essere completata con lo stabilizzatore centrale "6 0160 A".

Mensola inclinabile acciaio dx:
grigio bucciato 9006

Art. N.
420610P

Mensola inclinabile acciaio sx:
grigio bucciato 9006

420611P

Cavaliere centrale e/o laterale 60010



IN ACCIAIO NICHELATO

IN POLICARBONATO

Art. N.

Ig.48mm per mensola senza piaga acciaio nichelato

420559

Ig.53mm per mensola senza piega polycarbonato trasparente

420559A

Ventosa morbida

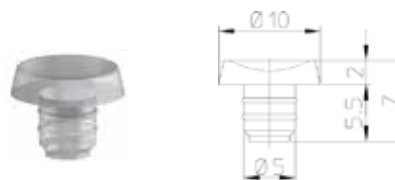

Art. N.

d.5mm silicone trasparente

420559B

Mensola per piani a sbalzo M0600A

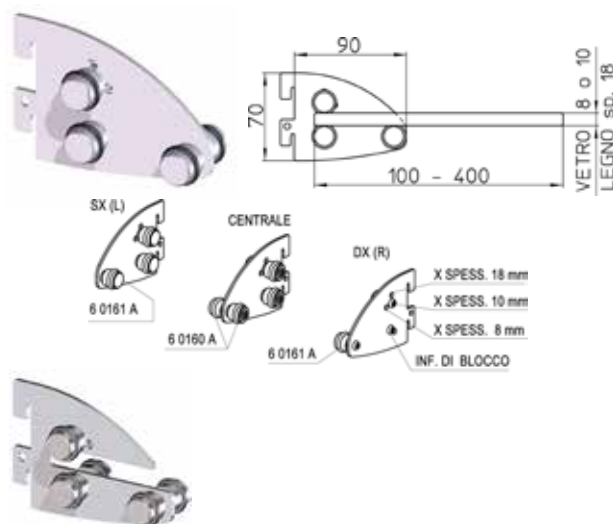

Mensole per PIANO in VETRO (8-10 mm)

Mensola Ig.90 per sp.8-10-18 centrale:
alluminio anodizzato argento

Art. N.
420615P

Mensola Ig.90 per sp.8-10-18 dx:
alluminio anodizzato argento

420616P

Mensola Ig.90 per sp.8-10-18 sx:
alluminio anodizzato argento

420617P

Mensola Ig.90 per sp.8-10-18 passante:
alluminio anodizzato argento

420618P



Staffa porta pensile piegata M0410F

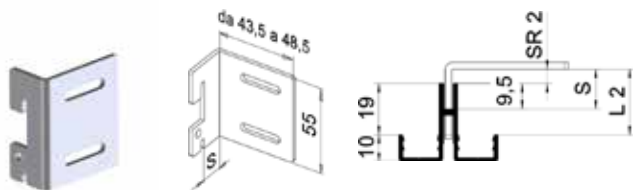

Art. N.

Dx S=10 SR2= 0.5 acciaio grigio bucciato 9006 **420586P**

Sx S=10 SR2= 0.5 acciaio grigio bucciato 9006 **420587P**

Dx S=15 SR2= 5.5 acciaio grigio bucciato 9006 **420588P**

Sx S=15 SR2= 5.5 acciaio grigio bucciato 9006 **420589P**

Staffa porta pensile dritta M0400F

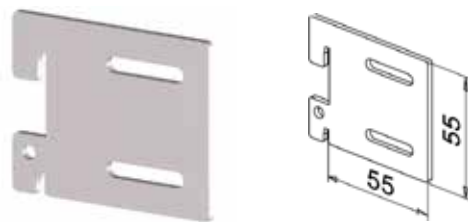

Art. N.

55x55 acciaio grigio bucciato 9006 **420590P**

Broche e appenderie

Mensola porta e appenderia con bloccaggio per tubo ovale da 30x15mm sp.1,5mm M0715F

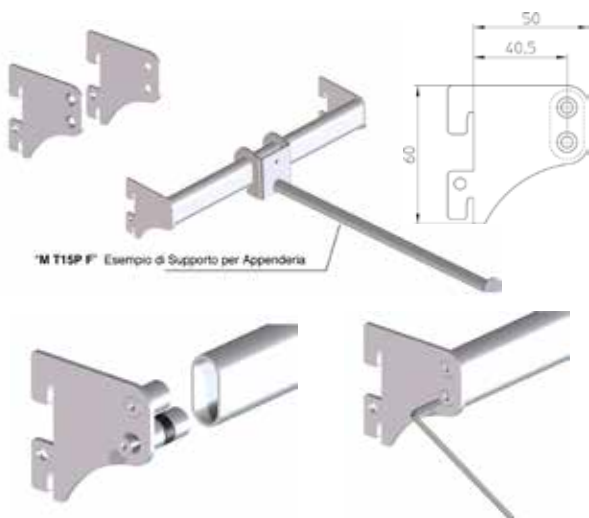

perni e viti compresi nella fornitura

Art. N.

Ig.50mm porta appenderia acciaio dx: cromato **420605P**

Ig.50mm porta appenderia acciaio sx: cromato **420606P**

Tubo ovale 30x15mm sp.1,5mm: cromo lucido **420607**

Broche dritta con attacco per tubo ovale 30x15



Art. N.

Lg.300mm cromo lucido **420605**

Broche doppia con attacco per tubo ovale 30x15 M715BF

su ordinazione



Art. N.

Lg.150mm cromo **420600**

Lg.200mm cromo **420601**

Lg.250mm cromo **420602**

Broche inclinata con per attacco per tubo ovale 30x15



Art. N.

Lg. 389mm con 9 pioli cromo lucido **420608**



Profilo cremagliera singola passo 50mm

su ordinazione

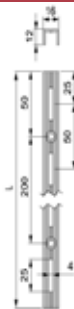

Art. N.

Lg. 2500mm acciaio bianco

420650

Profilo cremagliera doppia passo 32mm

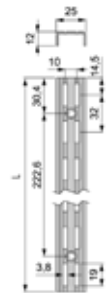

Art. N.

Lg. 2229mm acciaio bianco

420651

Reggimensola per cremagliera singola passo 50mm

su ordinazione

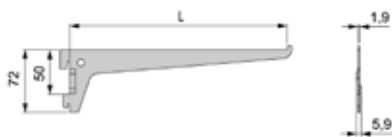

Art. N.

Lg. 200mm acciaio bianco

420660

Lg. 250mm acciaio bianco

420661

Lg. 300mm acciaio bianco

420662

Lg. 350mm acciaio bianco

420663

Reggimensola per cremagliera doppia passo 32mm

su ordinazione

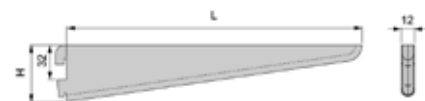

Art. N.

Lg.170mm H.47mm acciaio bianco

420670 ✓

Lg.220mm H.49mm acciaio bianco

420671 ✓

Lg.270mm H.52mm acciaio bianco

420672

Lg.320mm H.58mm acciaio bianco

420673 ✓

Lg.370mm H.64mm acciaio bianco

420674

✓ Su ordinazione



LOGO: un programma di strutture espositive in profilati d'alluminio, che permettono l'allestimento di spazi di svariata natura e attitudine, dal soggiorno alla cabina armadio, dalla cucina al bagno, dai negozi all'ufficio.





Montante a soffitto



Ig.3085mm
alluminio anodizzato

Art. N.
420900

completo di piedino e attacco soffitto/parete

Morsetto blocca cassetiera

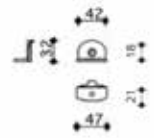

Coppia morsetto blocca cassettera
alluminio anodizzato

Art. N.
420904

Squadretta a 90°

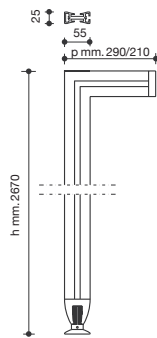

per giunzione montante a 90° zama

Art. N.
420901

Morsetto blocca mensola vetro

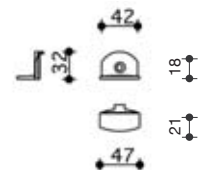

Coppia morsetto blocca mensola in vetro
alluminio anodizzato

Art. N.
420903

Supporto mensole



Coppia supporto mensola Ig.152mm
alluminio anodizzato

Art. N.
420902

Supporto tubo ovale



Coppia supporto tubo ovale
alluminio anodizzato

Art. N.
420905



Supporto per tasca porta servetto



	Art. N.
Coppia supporto per tasca porta servetto	420906
Tasca porta servetto grigia	420907

Attacco per soffitto

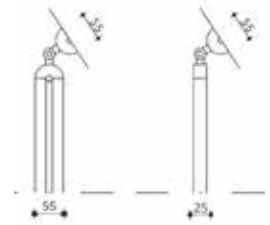

	Art. N.
Attacco per soffitto inclinato alluminio anodizzato	420908

Raccordo di fissaggio a parete

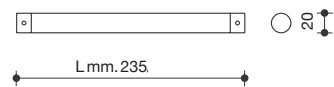

	Art. N.
per montante lg. 235mm alluminio anodizzato	420912

Piedino d.50 regolabile

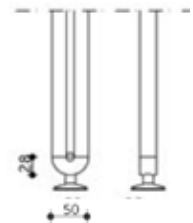

	Art. N.
alluminio anodizzato	420914

Supporto fissaggio a parete/soffitto



	Art. N.
Supporto fissaggio a parete/soffitto alluminio anodizzato	420915